

Homework 12-3
Surface Area

Find each unit rate. If necessary, round to the nearest hundredth.

1. 759 miles in 3 hours
2. 20 calls in 5 hours

Use proportions to convert the following customary units. Round to the nearest tenth if necessary.

3. 1,275 feet = _____ mile
4. 17 gallons = _____ quarts

Find the length of the missing side of each similar shape. Round to the nearest tenth if necessary.

5.

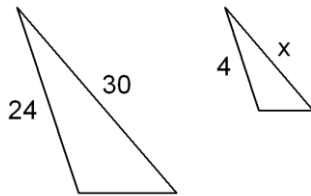

6.

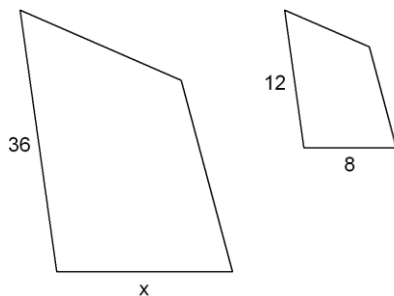

7. Find the approximate area of the lake shown on the grid below? (each square represents 1 square meter)

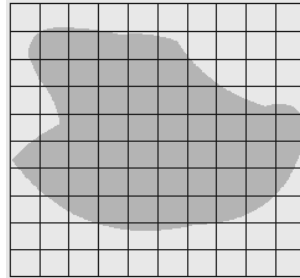

8.

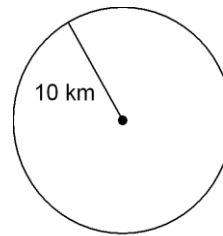

Circumference: _____

Area: _____

9.

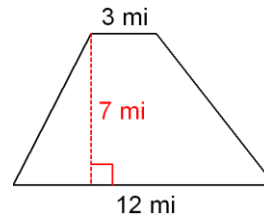

Area: _____

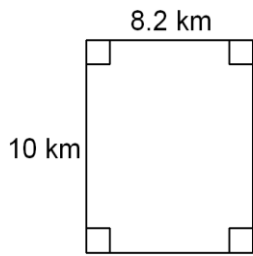

10.

Area: _____

Perimeter: _____

Find the surface area of each figure.

11.

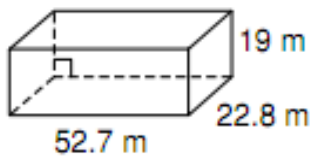

13.

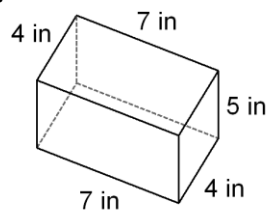

12.

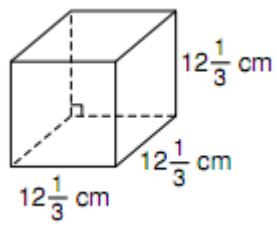

14.

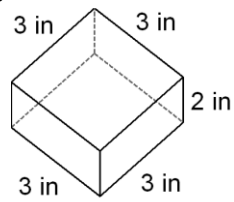

15.

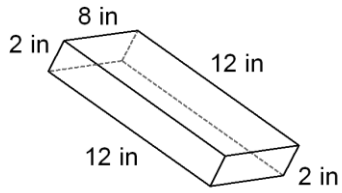

16.

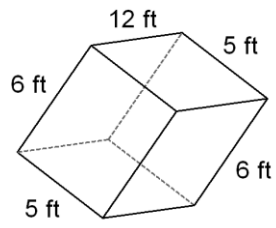

Find the surface area for the cylinders.

17.

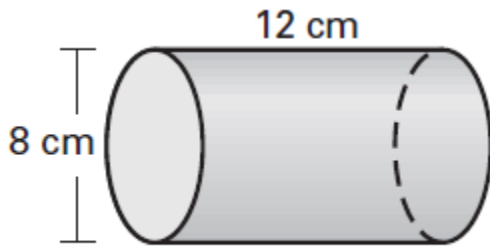

19.

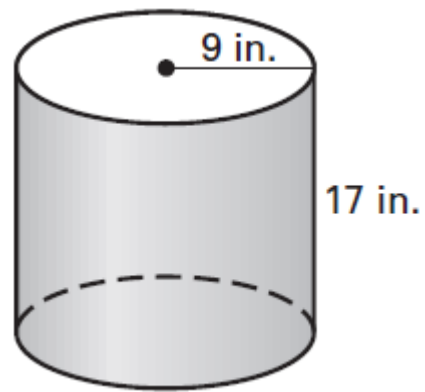

18.

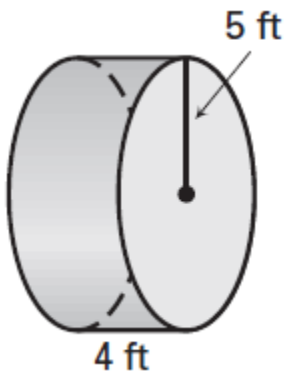

20.

